

DENON

Hi-Fi Component / Amplifier

SERVICE MANUAL

MODEL PMA-232

SOLID STATE STEREO INTEGRATED AMPLIFIER

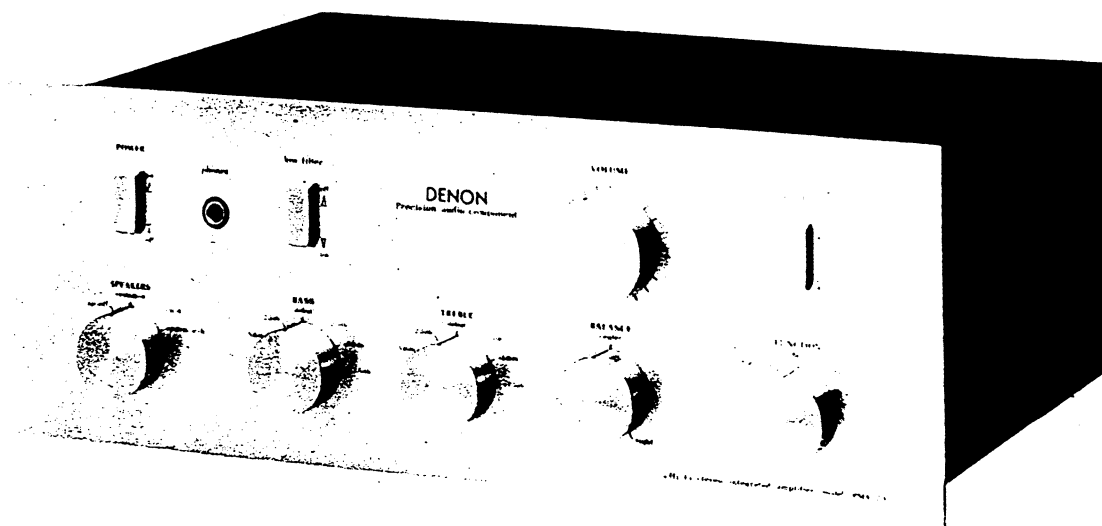

NIPPON COLUMBIA CO., LTD.

TABLE OF CONTENTS

SPECIFICATIONS	1	ETC-104 MUTING CONTROL UNIT PARTS LIST	7
DISASSEMBLY INSTRUCTIONS	2	CHASSIS & CABINET GROUP PARTS LIST	7
PRINTED CIRCUIT BOARD PATTERNS AND PARTS LIST		ADJUSTMENTS AND MEASUREMENT PROCEDURES	8
ETC-99B EQUALIZER, TONE AMP UNIT	3	WIRING DIAGRAM	9
ETC-85D POWER AMP PROTECTOR & POWER SOURCE UNIT	5		

SPECIFICATIONS

Type: All silicon transistor stereo pre-main amplifier

POWER AMPLIFIER & PRE AMPLIFIER SECTION

Circuit system: Pure complementary, Whole-stage-direct-connection, 7 power source OCL circuit

Rated output power: 45W/45W (load, 8 ohms) at T.H.D. 0.1%

(Each channel driven): 62 W/62W (load, 4 ohms) at T.H.D. 0.1%

Rated output power: 38W + 28W (load, 8 ohms) at T.H.D. 0.1%

(Both channel driven): 47W + 47W (load, 4 ohms) at T.H.D. 0.1%

Harmonic distortion: Lower than T.H.D. 0.1% (at 8 Watts and 20Hz to 20KHz)

Cross modulation

distortion: Lower than 0.1% (at equivalent sign wave rated output)

Power bandwidth: 20Hz - 30KHz (at T.H.D. 0.3%)

Input sensitivity/input

impedance: (at 1KHz) PHONO: 2.2mV r.m.s. 50K ohms $\pm 10\%$

TUNER: 14.0mV r.m.s. 80K ohms $\pm 10\%$

AUX: 14.0mV r.m.s. 80K ohms $\pm 10\%$

Maximum allowable: PHONO: More than 200mVr.m.s. (1KHz)

Input level:

Equalizing characteristic,

RIAA deviation: $\pm 0.4\text{dB}$ (at 20Hz - 20KHz, Rec out)

TONE CONTROL SECTION

Transmission: 20Hz - 50KHz $\pm 1\text{ dB}$ at TONE CENTER position

Tone control:

BASS: +7.5dB, -5.0dB at 100Hz
TREBLE: +7.5dB, -5.0dB at 10KHz

Low filter cutoff

frequency: 15Hz (-12.3dB)

Power requirement: AC 220/240V changeable, 50Hz, 120V 60Hz (For USA, Canada)

Power consumption: 250W

Dimensions: 396mm (W) x 147mm (H) x 281mm (D)

Weight: 9 Kg

DISASSEMBLY INSTRUCTIONS

REF. NO.	NO.	PARTS	REF. NO.	NO.	PARTS
1	1020032109	TOP COVER	16	2048014108	6P WRAPPING PIN JACK
2	411005105	MAIN CHASSIS	17	2048015107	4P WRAPPING PIN JACK
3	1040016008	FOOT	18	EP-71141	PUSH TERMINAL
4	1440165300	FRONT PANEL	19	2050043109	GND TERMINAL
5	1120091202	KNOB			
6	1120090106	KNOB			
7	1130065105	KNOB			
8	1160004107	KNOB SHEET			
9	4110077301	FRONT CHASSIS			
10	4310040400	SLIDER			
11	4430069015	COLLOR			
12	4140069004	SHIELD PLATE			
13	2062002002	AC CORD WITH PLUG			
14	2020012005	FUSE HOLDER			
15	2061015058	FUSE 1.6A (TIME LAG)			

PARTS LOCATION

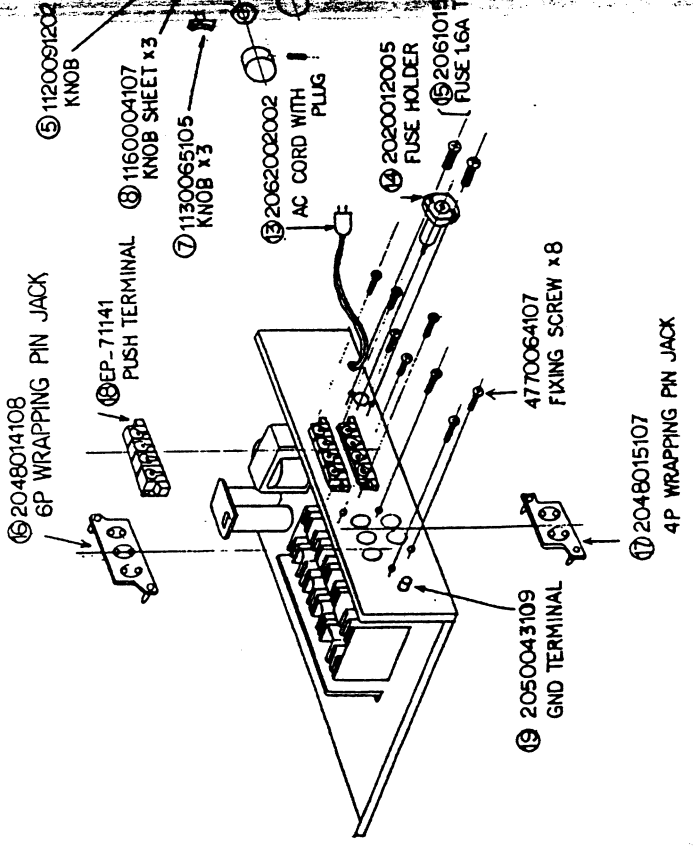
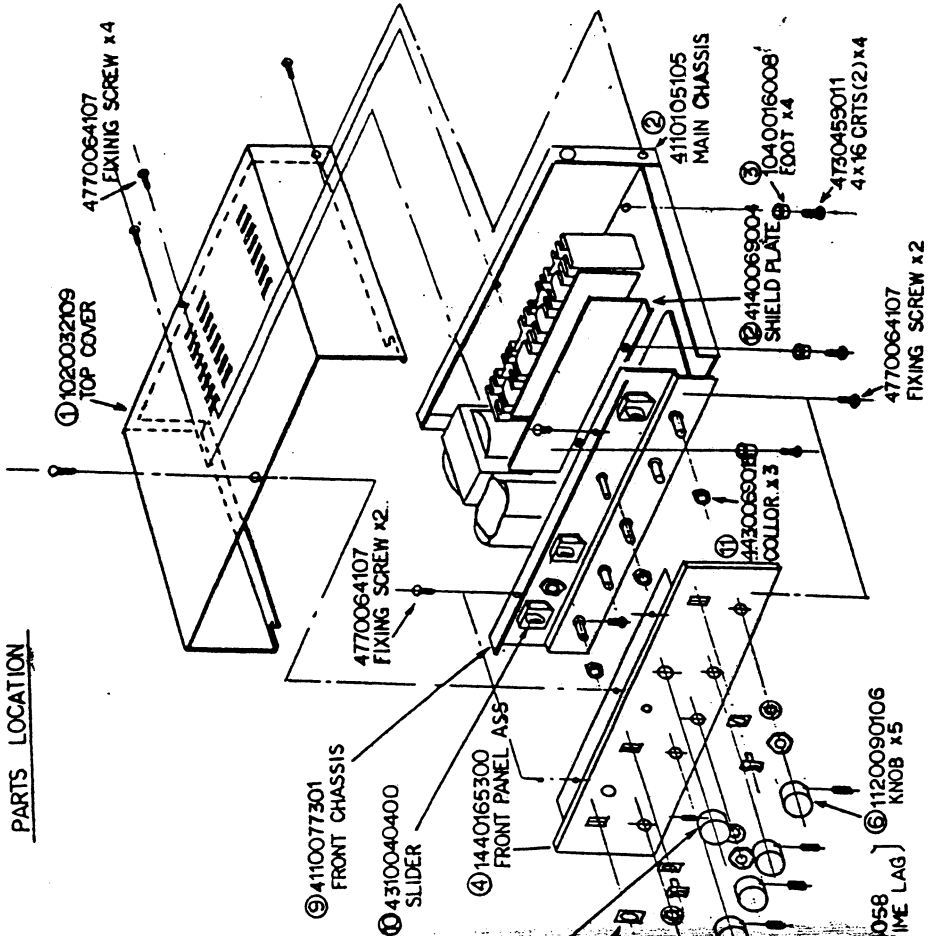

PRINTED CIRCUIT BOARD PATTERNS
AND PARTS LIST (The board diagram represents the view
from the copper foil side)

ETC-99B EQUALIZER, TONE AMP UNIT

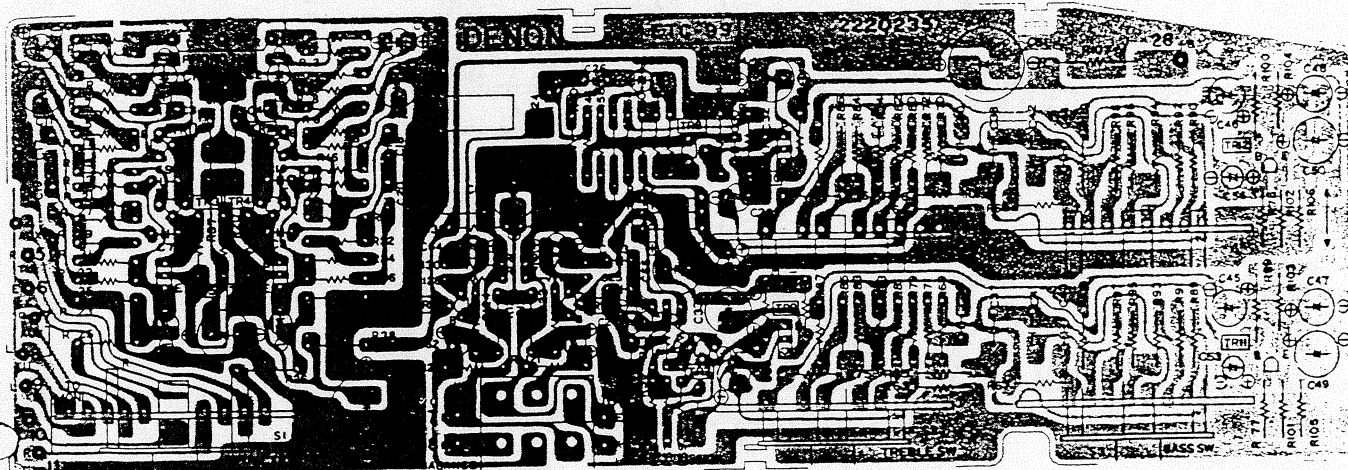

ETC-99B EQUALIZER, TONE AMP PARTS LIST

Ref. No.	Part No.	Part Name	Description		
C1,2,53,54	2544024016	CE04W1E4R7=F	4.7uF	25V	Electrolytic Capacitor
C3,4	2533631012	CC45SL1H151JF	150PF ±5%	50V	Ceramic Capacitor
C5,6	2544001013	CE04W0J330=F	33uF	6.3V	Electrolytic Capacitor
C7,8,9,10	2533623017	CC45SL1H680JF	68PF ±5%	50V	Ceramic Capacitor
31,32					
C11,12,49,50	2544004010	CE04W0J221=F	220uF	6.3V	Electrolytic Capacitor
C15,16	2541031002	CS45E1V2R2M	2.2uF ±20%	35V	Solid Tantalum Capacitor
C17,18	2551129001	CQ93M1H682JF	0.0068uF ±5%	50V	Plastic Film Capacitor
C19,20	2551128031	CQ93M1H182JF	0.0018uF ±5%	50V	"
C21,51	2544059010	CE04W1J221=F	220uF	63V	Electrolytic Capacitor
C22	2544059023	CE04W1J470=F	47uF	63V	"
C23,24,25,26	2551129027	CQ93M1H273JF	0.027uF ±5%	50V	Plastic Film Capacitor
C27,28,61,62	2541027003	CS45E1VR47M	0.47uF ±20%	35V	Solid Tantalum Capacitor
C29,30	2533635018	CC45SL1H221JF	220PF ±5%	50V	Ceramic Capacitor
C33,34	2544011016	CE04W1A221=F	220uF		Electrolytic Capacitor
C37,38,41,42	2551130032	CQ93M1H823JF	0.082uF ±5%	50V	Carbon Film Resistor
C39,40	2551128002	CQ93M1H102JF	0.001uF ±5%	50V	"
C43,44	2551128086	CQ93M1H472JF	0.0047uF ±5%	50V	"
C45,46,47,48	2544035018	CE04W1V100=F	10uF	35V	Electrolytic Capacitor
C52	2544015012	CE04W1C100=F	10uF	16V	"
C55	2544059007	CE04W1J101=F	100uF	63V	"
C63,64	2541020000	CS45E1E010M	1uF ±20%	25V	Solid Tantalum Capacitor
C65	2544028012	CE04W13101=F	100uF	25V	Electrolytic Capacitor
C35,36	2544045011	CE04W1H3R3=F	3.3uF	50V	"
R1,2	2410363005	RD14B2E114J	1/4W 110Kohm	±5%	Carbon Film Resistor
R3,4,45,46	2410314009	RD14B2E102J	1/4W 1Kohm	±5%	"
57,58,123					
124					
R5,6	2412016004	RD14B2E104JNL	1/4W 100Kohm	±5%	"
R7,8	2410321005	RD14B2E202J	1/4W 2Kohm	±5%	"
R9,10	2412016017	RD14B2E154JNL	1/4W 150Kohm	±5%	"
R11,12,101,102	2410316007	RD14B2E122J	1/4W 220 Ohm	±5%	"
R13,14,35,36	2410298002	RD14B2E221J	1/4W 220 Ohm	±5%	Carbon Film Resistor
R15,16	2410313000	RD14B2E911J	1/4W 910 Ohm	±5%	"
R17,18,59,60	2410315008	RD14B2E112J		±5%	"
R19,20,71,72	2410344008	RD14B2E183J	1/4W 18Kohm	±5%	"
R21,22	2410326000	RD14B2E332J	1/4W 3.3Kohm	±5%	"
R23,24,129	2410362006	RD14B2E104J	1/4W 100Kohm	±5%	"
130					
R25,26	2410286001	RD14B2E680J	1/4W 68 Ohm	±5%	"
R27,28,49,50	2410370001	RD14B2E224J	1/4W 220Kohm	±5%	"

Ref. No.	Part No.	Part Name	Description		
R29,30	2410372009	RD14B2E274J	1/4W 270Kohm	±5%	Carbon Film Resistor
R31,32,33,34	2410345007	RD14B2E203J	1/4W 20Kohm	±5%	"
R37,93,94	2410338001	RD14B2E103J	1/4W 10Kohm	±5%	"
R38	241029000	RD14B2E101J	1/4W 100 Ohm	±5%	"
R39,40	2420193016	RC05GF2E155KF	1/2W 1.5Mohm	±10%	"
R43,44,47,48	2410365003	RD14B2E134J	1/4W 130Kohm	±5%	"
R51,63,64	2410378003	RD14B2E474J	1/4W 470Kohm	±5%	"
105,106					
R52	2410352003	RD14B2E393J	1/4W 39Kohm	±5%	"
R53,54	2410341001	RD14B2E133J	1/4W 13Kohm	±5%	"
R55,56	2410302008	RD14B2E331J	1/4W 330 Ohm	±5%	"
R61,62	2410312001	RD14B2E821J	1/4W 820 Ohm	±5%	"
R65,66,67,	2410342000	RD14B2E153J	1/4W 15Kohm	±5%	"
68,109,110					
R69,70	2410335004	RD14B2E752J	1/4W 7.5KOhm	±5%	"
R73,74,75,76	2420203016	RC05GF2E106KF	1/2W 10Mohm	±10%	Carbon Composite Resistor
R77,78	2410360008	RD14B2E823J	1/4W 82Kohm	±5%	Carbon Film Resistor
R79,80,87,88,	2410339000	RD14B2E113J	1/4W 11Kohm	±5%	"
R81,82,85,86	2410343009	RD14B2E163J	1/4W 16Kohm	±5%	"
R84,83,132	2410354001	RD14B2E473J	1/4W 47Kohm	±5%	"
R89,91,92,97,98	2410330009	RD14B2E472J	1/4W 4.7Kohm	±5%	"
R95,96	2410331008	RD14B2E512J	1/4W 5.1Kohm	±5%	"
R99,100	2410253018	RD14B2H684JF	1/2W 680Kohm	±5%	"
R103,104	2410334005	RD14B2E682J	1/4W 6.8Kohm	±5%	"
R107	2440033017	RS14B3A221JNBF	1W 220 Ohm	±5%	Metal Oxide Resistor
R121,122	2420195014	RC05GF2E225KF	1/4W 2.2Mohm	±10%	Carbon Composite Resistor
R125,126	2410374007	RD14B2E334J	1/4W 330Kohm	±5%	Carbon Film Resistor
R127,128	2410336003	RD14B2E822J	1/4W 8.2Kohm	±5%	"
R131	2410346006	RD14B2E223J	1/4W 22Kohm	±5%	"
TR1,2,3,4	2730158013	2SC1775(F)	Transistor		
7,8,11,12					
TR5,6	2730161000	2SC1212AWT(B)	"		
TR9,10	2730161000	2SA743A(B)	"		
TR21,22	2730158013	2SC1775(F)	"		
S1	2120062007	Function Switch			
S2	2120064005	Treble Switch			
S3	2120063006	Base Switch			
VR2	2110092003	V2422P25RZ254K	For Balance Volume		
	EP-56671H	Terminal			
	2220235006	Printed Circuit Board			

ETC-85D POWER AMP PROTECTOR & POWER SOURCE UNIT

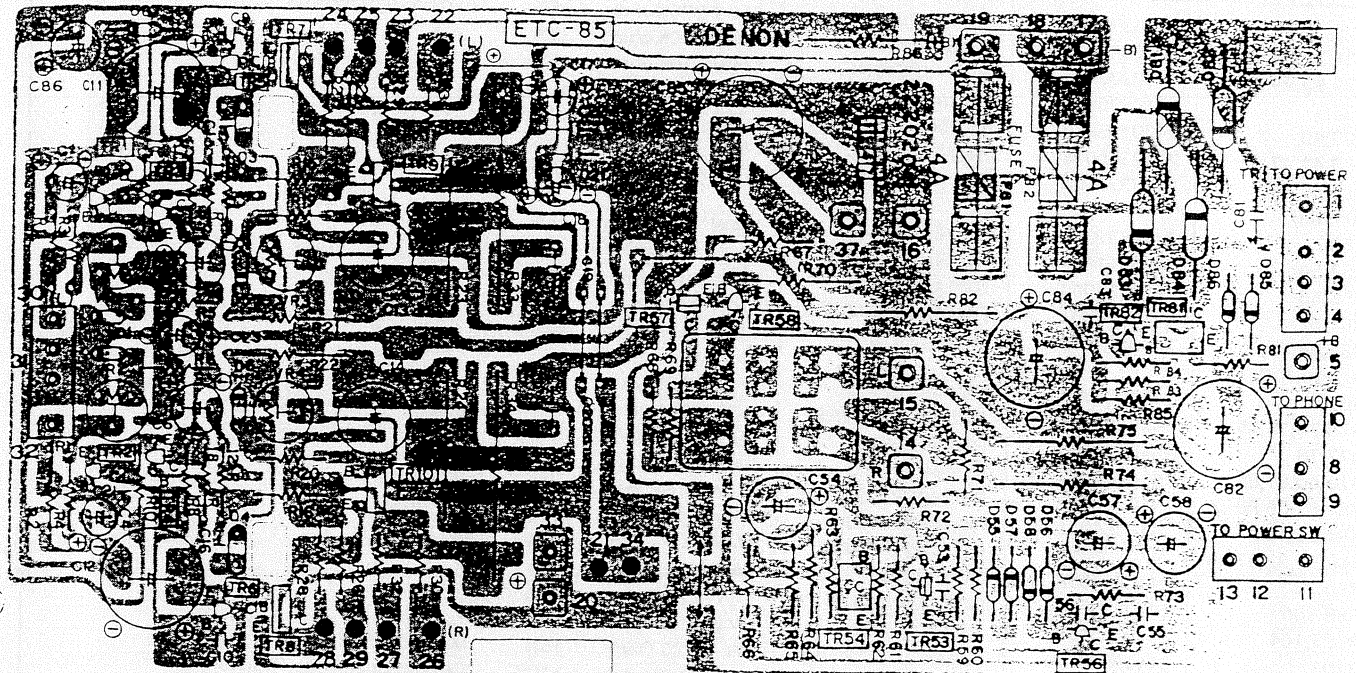

ETC-85D POWER AMP PROTECTOR & POWER SOURCE UNIT PARTS LIST

Ref. No.	Part No.	Part Number	Description		
C1,2	2544044012	CE04W1H010=F	1uF	50V	Electrolytic Capacitor
C3,4	2533623017	CC45SL1H680JF	68PF	±5% 50V	Ceramic Capacitor
C5,6	2544003011	CE04W0J101=F	100uF	63V	Electrolytic Capacitor
C7,8	NON				
C9,10	2533621019	CC45SL1H560JF	560PF	±5% 50V	Ceramic Capacitor
C11,12	2544051018	CE04W1H221=F	220uF	50V	Electrolytic Capacitor
C13,14	2544039001	CE04W1V221=F	220uF	35V	"
C15,16	2533595019	CC45SL1H020CF	2PF	±5.25PF 50V	Ceramic Capacitor
C17,18,23	2544046010	CE04W1H4R7=F	4.7uF	50V	Electrolytic Capacitor
C19,20	2551130045	CQ93M1H104JF	0.1uF	±5% 50V	Plastic Film Capacitor
C21,22	2531026014	CK45F1H473ZF	0.047uF	50V	Ceramic Capacitor
C51,52	NON				
C53,55	2531021019	CK45F1H102ZF	0.001uF	50V	"
C54	2549005030	CE04=1E100MHS	10uF	25V	Electrolytic Capacitor
C56	2531050019	CK45E2H102PF	0.001uF	500V	Ceramic Capacitor
C57,58	2544006018	CE04W0J471=F	470uF	7.3V	Electrolytic Capacitor
C81	2531053016	CK45E2H103PF	0.01uF	500V	Ceramic Capacitor
C82	2544063019	CE04W1K221=F	220uF	80V	Electrolytic Capacitor
C83	2531002012	CK45B1H471KF	470PF	50V	Ceramic Capacitor
C84	2544063006	CE04W1K101=F	100uF	80V	Electrolytic Capacitor
C85	2544053003	CE04W1H471=F	470uF	50V	"
C86	2544026001	CE04W1E330=F	33uF	50V	"
R1,2,19,20	2410314012	RD14B2E102JF	1/4W 1Kohm	±5%	Carbon Film Resistor
R3,4	2410360011	RD14B2E823JF	1/4W 82Kohm	±5%	"
R5,6	2410347018	RD14B2E243JF	1/4W 24Kohm	±5%	"
R7,8	2410320019	RD14B2E182JF	1/4W 1.8Kohm	±5%	"
R9,10	2410336016	RD14B2E822JF	1/4W 8.2Kohm	±5%	"
R11,12	2410317019	RD14B2E132JF	1/4W 1.3Kohm	±5%	"
R13,14	NON				
R15,16,83	2410346019	RD14B2E223JF	1/4W 22Kohm	±5%	"
R17,18,25 26,27,28	2410290013	RD14B2E101JF	1/4W 100 Ohm	±5%	"
R21,22	2442001021	RS14B3A242JNBF	1W 2.4Kohm	±5%	Metal Oxide Film Resistor
R23,24	2440096012	RS14B3D681JNBF	2W 680 Ohm	±5%	"
R29,30,31 32	2430023008	RW99=3FR47J	3.15W 0.47 Ohm	±5%	Wire wound Resistor
R33,34	2440129015	RS14B3F100JNBF	3.15W 10 Ohm	±5%	Metal Oxide Film Resistor
R51~58	NON				
R59	2410342013	RD14B2E153JF	1/4W 15Kohm	±5%	Carbon Film Resistor
R60,69,71,72	2410338014	RD14B2E103JF	1/4W 10Kohm	±5%	"

Ref. No.	Part No.	Part Name	Description
R61	NON		
R62	2410354014	RD14B2E473JF	1/4W 47Kohm ±5% Carbon Film Resistor
R63	2410276011	RD14B2E270JF	1/4W 27 Ohms ±5% "
R64	2410255016	RD14B2H824JF	1/2W 820Kohm ±5% "
R65	2410376018	RD14B2E294JF	1/4W 390Kohm ±5% "
R66	NON		
R67	2410257014	RD14B2H105JF	1/2W 1Mohm ±5% "
R68	2410332010	RD14B2E562JF	1/4W 5.6KOhm ±5% "
R70	2440034016	RS14B3A271JNBF	1W 270 Ohm ±5% Metal Oxide Film Resistor
R73	2410330012	RD14B2E472JF	1/4W 4.7Kohm ±5% Carbon Film Resistor
R74,75	2440090018	RS14B3D221JNBF	2W 220 Ohm ±5% Metal Oxide Film Resistor
R81	EP-6975	Fuseble Resistor	2.2 Ohm
R82	2440098010	RS14B3D102JNBF	2W 1Kohm ±5% Metal Oxide Film Resistor
R84	2410298015	RD14B2E221JF	1/4W 220 Ohm ±5% Carbon Film Resistor
R85	2410378016	RD14B2E474JF	1/4W 470Kohm ±5% Carbon Film Resistor
R86	2442003029	RS14B3D511JNB	2W 510 Ohm ±5% Metal Oxide Film Resistor
R90	2410338001	RD14B2E103J	1/4W 10Kohm ±5% Carbon Film Resistor
VR1,2	EP-546211H	Solid Volume	4.7Kohm Variable Resistor
VR3,4	EP-54625H	"	470 Ohm Variable Resistor
TR1,2,3,4	2730158026	2SC1775 (E)	Transistor
TR5,6	2710072009	2SA850(D)	"
TR7,8,54,81	2730161000	2SC1212AWT(B)	"
TR9,10	2710071000	2SA743A(B)	"
TR11,12	2740040001	2SD581(B)	Transistor (Out Put Power)
TR13,14	2720027002	2SB611(B)	Transistor (Out Put Power)
TR51,52	NON		
TR53	2710040057	2SA673A (C)	Transistor
TR56,82	2730158013	2SC1775(F)	"
TR57	2730116039	2SC1345(D)	"
TR58	2730162009	2SC1775A(F)	"
D1,2	2760155028	VD1122	Varistor
D3,4	2760132025	STV-3H(O)	Diode
D5,6	2760156027	VD1222	Varistor
E55,56,57,58	2760001004	1N34A	Diode
D85,86	2760057016	V06C	Diode
D87	2760067006	AW01-15	Zenner Diode
F81,82	EP-71329	Fuse 4A (Time Lug)	For "+B" "-B" Fuse
	EP-5870	Fuse Holder	
	4170045001	Radiator	For TR11,12,13, and 14
		Insulating Sheet	For TR11,12,13, and 14
	EP-6071	Base Pin	
	2034025004	3P Connector (B) plug	
	2036026001	4P Connector (B) Plug	
	4150065001	Holder	For P.C. Board Holder
	2220204202	Printed Circuit Board	

ETC-104 MUTING CONTROL PARTS LIST

Ref. No.	Part No.	Part Name	Description
C1,2	2551114003	CQ93M2D473M	0.047 uF 200V ±50%
R1,2	2410360008	RD14B2E823J	1/4W 82Kohm ±5% Carbon Film Resistor
R3	2410365003	RD14B2E134J	1/4W 130Kohm ±5% "
D1,2,3,4	2760057016	V06C	Diode
	EP-5667H	Terminal	
	2220282004	Printed Circuit Board	

GE-4003-1 CHASSIS & CABINET GROUP

Ref. No.	Part No.	Parts Name	Remarks
C1,2,3	2518001007	CP05C=AC103MC	0.01uF ±20% 450VAC Oil Capacitor
	2546011001	CF64W1H682=	68000uF 50V Electrolytic Capacitor
	2124047002	Slide Switch	For Power on off Switch
	2120060009	Speaker Switch	For Voltage Selector Switch
	2124048001	Slide Switch	For Speaker Switch
			For Tape Monitor Switch
			For Filter Switch
	2048008004	Head Phone Jack	
	3930017034	Lamp Ass'y	For Pilot Lamp (6.3V, 0.15A)
	2110118000	V2420N30KR254	For Main Volume
	EP-71141	Push Terminal	For Speaker Connecting Terminal
	2048015107	4P Wrapping Pin Jack	For Tape Jack
	2048014108	6P Wrapping Pin Jack	For Phono, Aux, Tuner Input Jack
	2090012006	Short Pin	For Tape PB Short Pin
	2850047008	Earth Terminal	For Gnd. Terminal
	2020012005	Fuse Holder	For AC Line Fuse Holder
	2061015058	Fuse 1.6A (Time Lag)	For AC Line Fuse
	2062002002	AC Cord with Plug	For Europe
	2062009005	AC Cord with Plug	For Australia
	2034059038	3P Connector Cord	For Connection Cord From ETC-85 To Head Phono
	2034069028	3P Connector Cord	For Connection Cord
	2030079009	1P Connector Ass'y	For Connection Cord From SP SW To ETC-85
	2030076028	1P Connector (A) Ass'y	For Connection Cord From Earth to ETC-85
2030072035	1P Connector (A) Ass'y	For Connection Cord From SP SW To ETC-85	
2030070079	1P Connector Ass'y	For Connection Cord From Earth To ETC-85	
2335023103	Power Trans Ass'y		
1440165106	Front Panel Ass'y		
1120091202	Knob	For Main Volume	
1120091016	Knob	For Function, Balance, Bass, Treble and Speaker	
1130065105	Knob	For Power, Low Filter and Monitor Switch	
1160004000	Knob Sheet		
1020032002	Top Cover		
4110104203	Main Chassis Ass'y		

ADJUSTMENTS AND MEASUREMENTS PROCEDURES

INSTRUCTIONS FOR ADJUSTING MIDPOINT ELECTRIC POTENTIAL AND IDLING ELECTRIC CURRENT OF POWER AMPLIFIER UNIT.

To ensure accurate adjustment of the midpoint electric potential and idling electric current of the PMA-232 Power Amplifier Unit (ETC-85), and adjustment should be performed in the manner indicated below:

1. MEASURING INSTRUMENTS

- A. DC Voltmeter (200mV)
- B. DC Ammeter (100mA)

Note: One each of the above mentioned instruments will suffice if a test is conducted on only one channel at a time.

2. CONNECTION

- A. Connect one DC voltmeter to the left and one to the right channel of the SPEAKER terminals. (See Fig. 18)
- B. Remove the plug (red wire) from the No. 1 terminal (+B) of the Power Amplifier Unit (ETC-85) and connect the DC ammeter to each channel. (See Fig. 19)

3. PROCEDURES

- A. Set the power supply at pre-set voltages of the PMA-232 (AC 220/240V:50Hz, 120V (FOR USA, CANADA))
- B. Wait three minutes after Power switch is ON.

- C. For adjusting midpoint voltage, turn the VR-1 (4.7 Kohm) so that voltage reading on the DC voltmeter (V) becomes 0 (zero): $V=0$. The condition is abnormal if the value exceeds 100 mV.
- D. Following adjustment of the midpoint voltage potential, adjust the idling electric current to 45 mA on the DC ammeter by rotating the VR-2 (470 ohm). $I=45mA$. Lock it with paint after adjustment is completed.

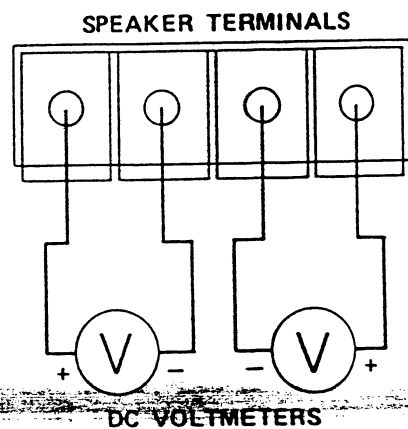

Fig. 1

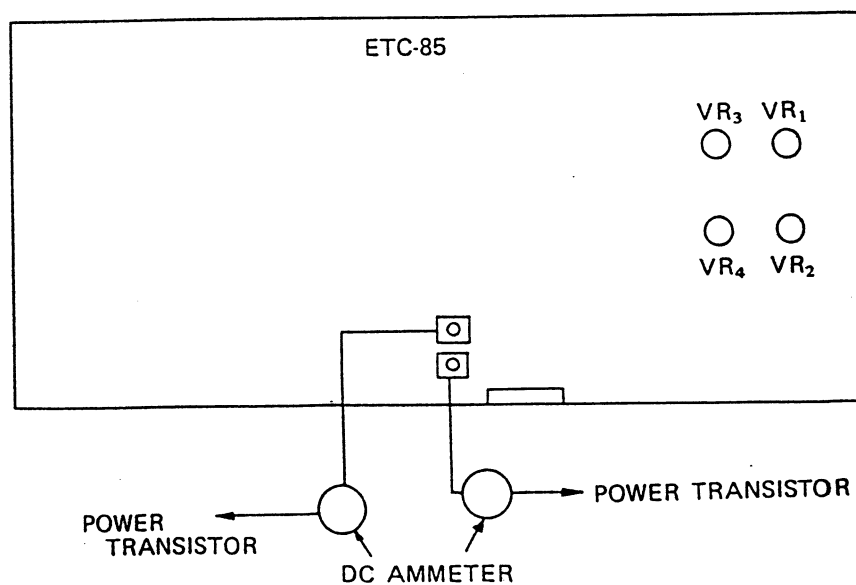
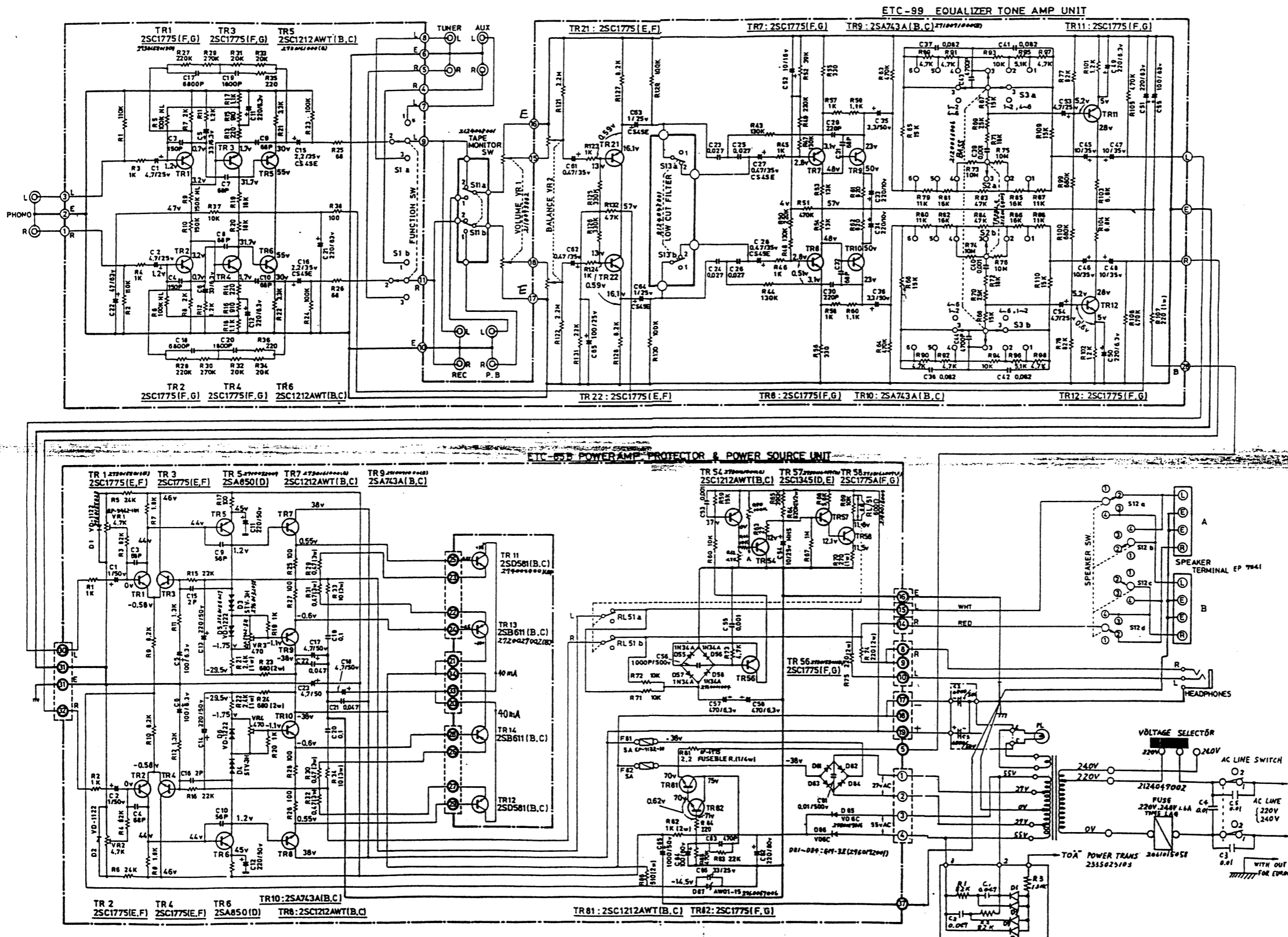

Fig. 2

DENON MODEL PMA-232 WIRING DIAGRAM



NOTES:

- ALL RESISTANCE VALUES IN OHM(S), K = 1,000 OHMS, M = 1,000,000 OHMS.
- ALL CAPACITANCE VALUES IN MICRO FARAD(S), P = MICRO-MICRO FARADS.
- EVERY VOLTAGES AND CURRENTS IS MEASURED AT NO SIGNAL INPUT CONDITION.

- ⊙ S1a-b : FUNCTION SW (1-AUX . 2-PHONO . 3-TUNER)
- ⊙ S2a-b : TREBLE SW (1--5dB . 2--2.5dB . 3-0dB . 4--2.5dB . 5--5dB . 6--7.5dB)
- ⊙ S3a-b : BASS SW (1--5dB . 2--2.5dB . 3-0dB . 4--2.5dB . 5--5dB . 6--7.5dB)

- ⊙ S10a-b : POWER SW (1-ON . 2-OFF)
- ⊙ S11a-b : TAPE MONITOR SW.....(1-TAPE . 2-SOURCE)
- ⊙ S12a-b : SPEAKER SW(1 OFF . 2-A . 3-B . 4--B)
- ⊙ S13a-b : LOW CUT FILTER.....(1-.ON . 2-OFF)